

完成図 - 側面

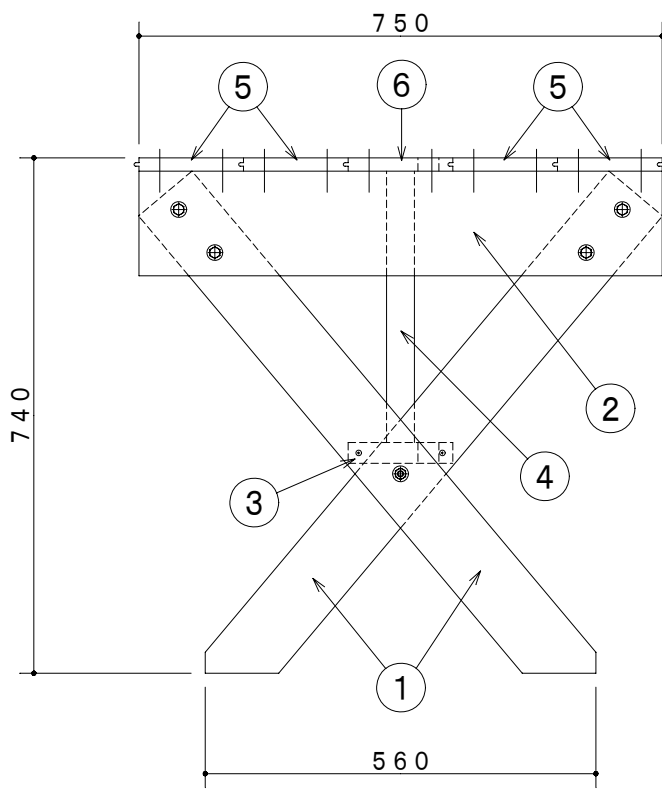

完成図 - 正面

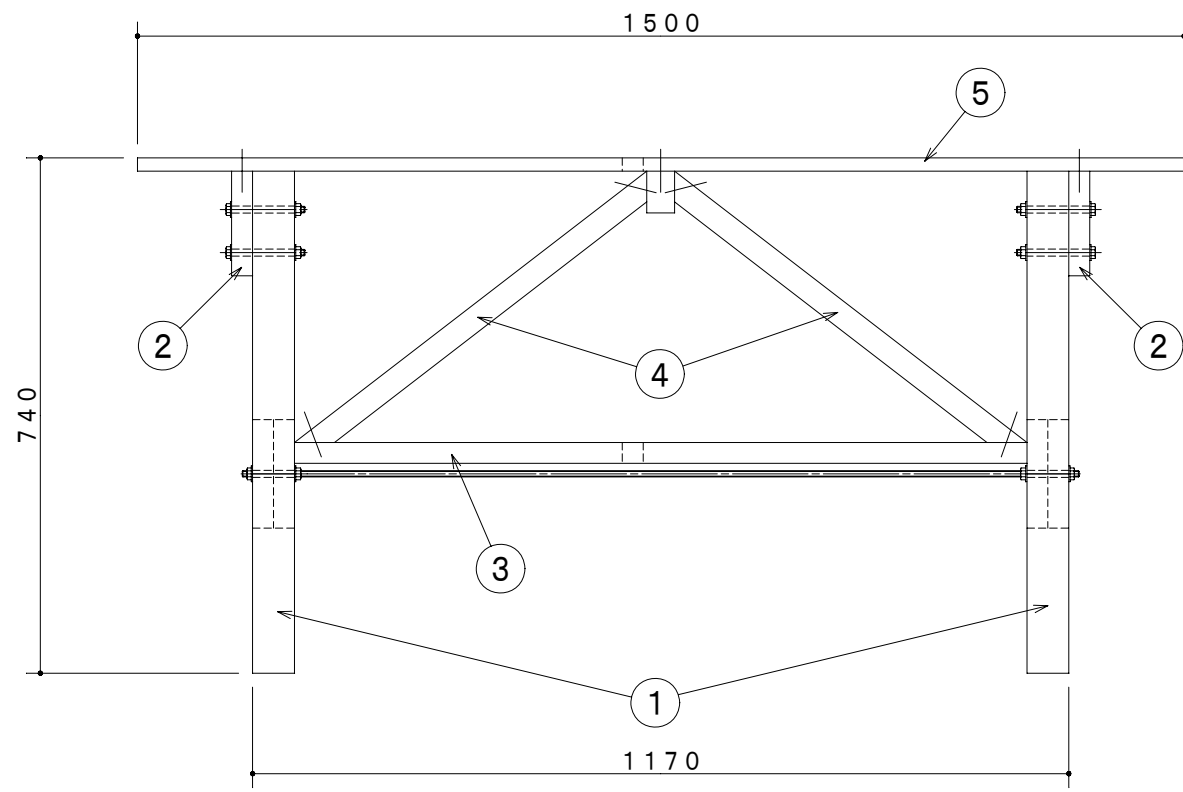

部品図

① × 4

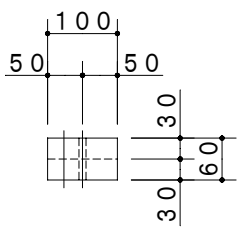

② × 2

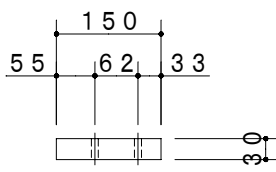

③ × 1

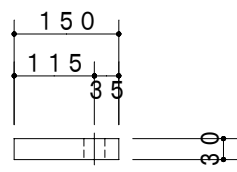

④ × 2

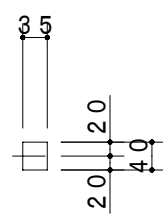

⑤ × 4

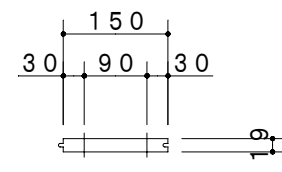

⑥ × 1

